

155

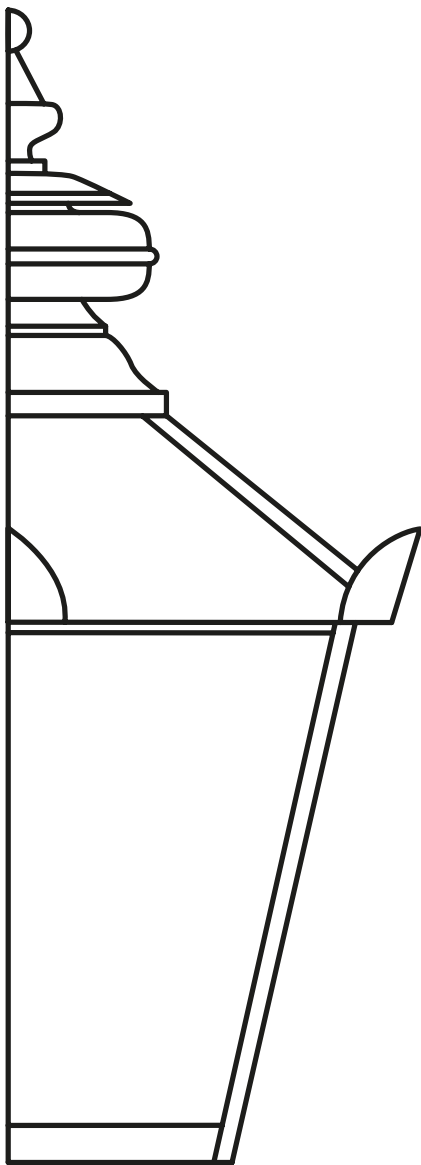

350

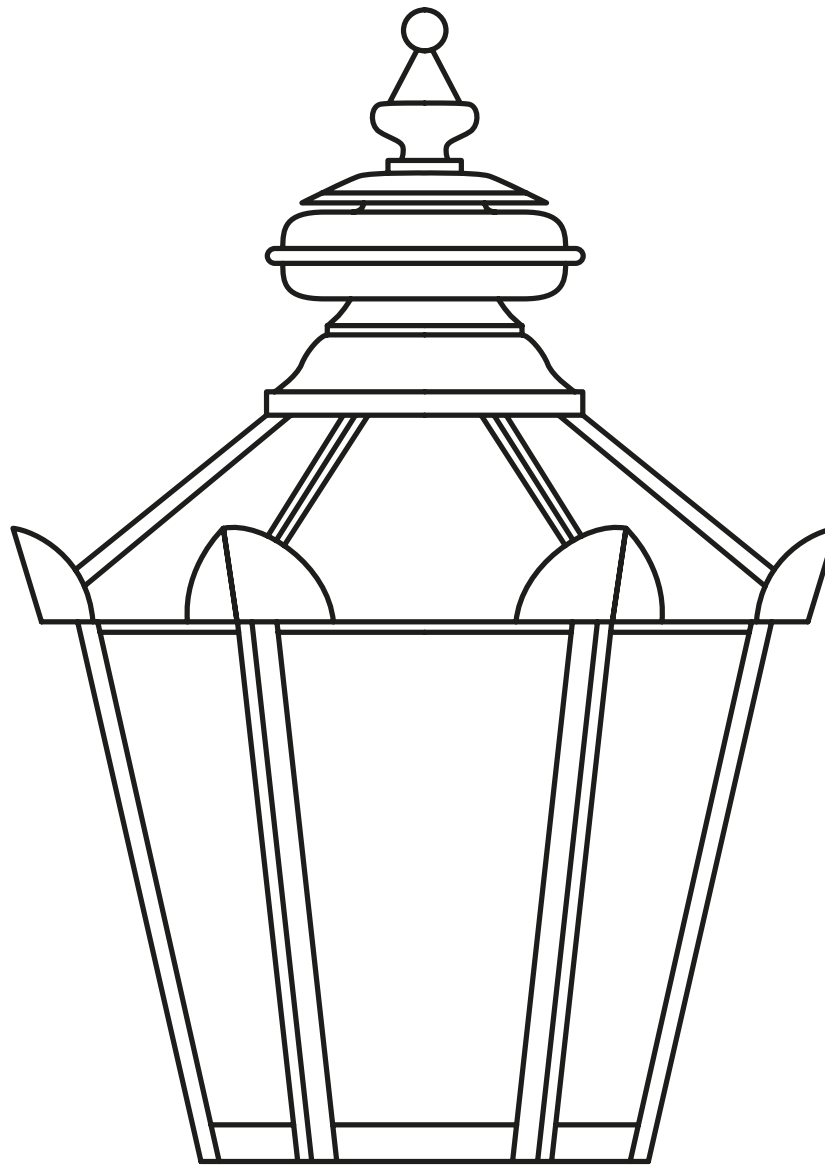

490

